

Article number: 20193B30V30602SW
 Description: E+G T-angle clamp
 GN 193-B30-V30-60-2-SW

Measures

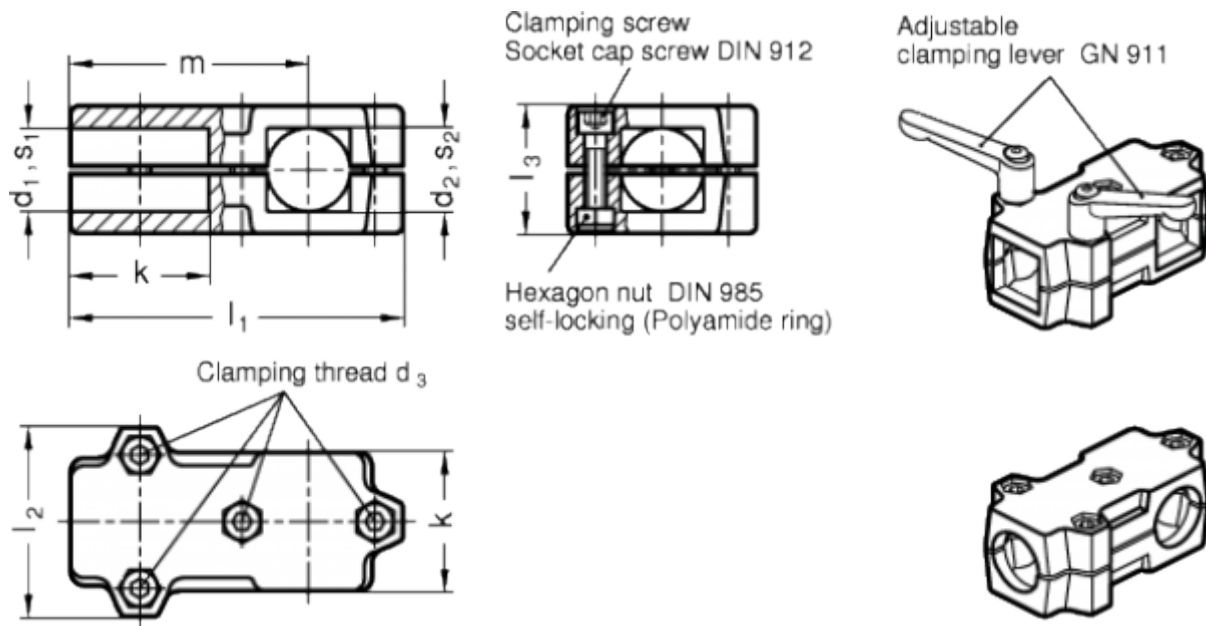

Accessories = GN 911-M10-55	m	= -
d1 = 30	s1	= -
d2 = -	s2	= 30
d3 = M8	Weight in (g)	= 728
k = 60		
l1 = 141		
l2 = 79		
l3 = 59		